

# Elektron.

Industrial Furniture

2025

NIP: PL6842640074

REGON: 360939126

KRS: 0000749874

INSPIRED BY  
QUALITY AND  
PRECISION

Polish manufacturer of metal Furniture



CONTRACT FURNITURE  
MANUFACTURING

EN

# ABOUT US

## Comprehensive manufacturing of projects based on customer concepts.

We are a company providing comprehensive services in metalworking. We offer a varied range of custom metal processing services, including the production of furniture, store display fixtures, and architectural products. We can become your trusted supplier for manufacturing services in the EU market.

### Certificates

Elektron sp. z o.o. operates a quality management system certified to ISO 9001, ISO 1090 EXC3, and ISO 3834 standards, ensuring the delivery of high-quality services through efficient processes and procedures.



### OUR EXPERIENCE

Elektron has 7 years of market experience in manufacturing steel components and combining them with non-steel materials.



### END-TO-END SERVICE

A comprehensive overview of the process, from initiation to completion.



### PLANT & MACHINERY

We invest in experienced personnel, modern equipment and technology.



### ORGANIZATION AND WORK CULTURE

We focus on high work organization to deliver quality products while minimizing unnecessary costs. Our goal is to offer our customers mutually beneficial cooperation.



Elektron sp. z o.o.



EN 1090-1+A1  
LL-C (Certification)



EN ISO 3834-2  
LL-C (Certification)



ISO 9001  
LL-C (Certification)

Address: Sulistrowa 33, 38-462 Sulistrowa,

Poland

Email: [biuro@web-elektron.pl](mailto:biuro@web-elektron.pl)

Phone: (+48) 13 307 0303

VAT: PL6842640074

REGON: 360939126

KRS: 0001022315



[webelektron.com](http://webelektron.com)

# CONTENTS

## OUR PROJECTS

### COFFEE TABLES

- DCT.01
- DCT.02
- DCT.03
- DCT.04
- DCT.05
- STK.01
- STK.02

### DINING TABLES

- ST.01
- ST.02
- ST.03

### INDUSTRIAL DESKS

- DSK.01 - RECTANGLE
- DSK.02 - TRIANGLE
- DSK.03 - BRICK
- DSK.04 - CHAIN
- DSK.05 - CUBE
- DSK.06 - MIX

### ADDITION COLLECTION

- AK.01
- AK.02

# IMPORTANT INFORMATION



In this catalog, we would like to introduce our furniture products. **Each product can be personalized to your needs.** We are engaged in **contract manufacturing** - we can produce furniture according to the designs developed by us or customize the design to meet the expectations of our customers.

- High quality furniture from Polish manufacturer
- Possibility of personalization of products
- Furnitures packed in cardboard boxes
- Shipping throughout Europe

Our products are made of powder-coated steel combined with wood, wood base panel and mdf panels.

<p><b>Coat of paint</b></p>	<p>The outdoor furniture we produce has two coatings, a zinc coating and a powder coating. Furniture for indoor use has one coating - a powder coating. Standard colors are gloss black and gloss white. We realize furniture in all RAL colors.</p>
<p><b>Furniture tops</b></p>	<p>We offer furniture with different versions of tops. Depending on the customer's needs and budget, we realize furniture with solid wood, laminated board and MDF tops.</p>



We process orders for standard products starting from 20 pieces. For orders of personalized products, the minimum order quantity depends on the complexity of personalization.



## STANDARD PRODUCT PARAMETERS

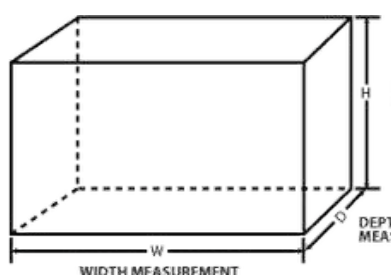

<p><b>Table Top</b></p>	<p>Oak wood / Laminated board</p>
<p><b>Table top thickness</b></p>	<p>Oak wood - 20mm / 40mm Laminated board 18mm / 36mm</p>
<p><b>Powder coating colour</b></p>	<p>white or black</p>
<p><b>Finish</b></p>	<p>matt or gloss</p>

# COFFEE TABLES



- DCT.01
- DCT.02
- DCT.03

- DCT.04
- DCT.05

- STK.01
- STK.02



# COFFEE TABLES

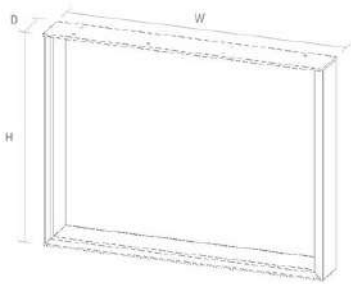

## DCT.01

	D (mm)	W (mm)	H (mm)	Top (mm)
DCT01-1	60	600	450	600
DCT01-2				800
DCT01-3				1000
DCT01-4				1200

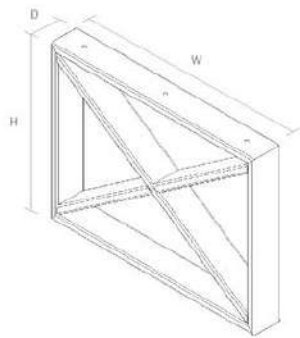

## DCT.02

	D (mm)	W (mm)	H (mm)	Top (mm)
DCT02-1	60	600	450	800
DCT02-2				1000
DCT02-3				1200

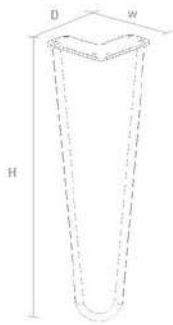

## DCT.03

	D (mm)	W (mm)	H (mm)	Top (mm)
DCT03-1	110	110	450	600
DCT03-2				800
DCT03-3				1000
DCT03-4				1200



# COFFEE TABLES

## DCT.04

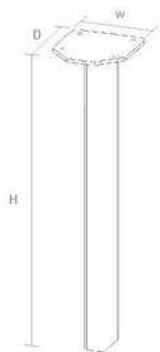

	D (mm)	W (mm)	H (mm)	Top (mm)
DCT04-1	120	110	450	600
DCT04-2				800
DCT04-3				1000
DCT04-4				1200

## DCT.05

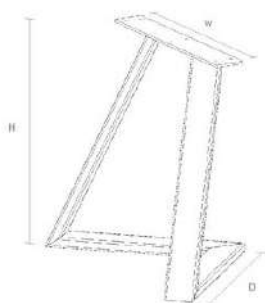

	D (mm)	W (mm)	H (mm)	Top (mm)
DCT05-1	390	400	450	800
DCT05-2				1000
DCT05-3				1200



## STK.01



	D (mm)	W (mm)	H (mm)
STK.01-1	500	500	500
STK.01-2	400	400	400

**STK.02**



	D (mm)	W (mm)	H (mm)
STK.02-1	500	500	500
STK.02-2	400	400	400



# DINING TABLES



- ST.01
- ST.02
- ST.03





# DINING TABLES

## ST.01



	H (mm)	Top (mm)
ST01-1	750	1600 x 900
ST01-2		1800 x 900
ST01-3		2000 x 900

## ST.02



	H (mm)	Top (mm)
ST02-1	750	1600 x 900
ST02-2		1800 x 900
ST02-3		2000 x 900

## ST.03



	H (mm)	Top (mm)
ST03-1	750	1600 x 900
ST03-2		1800 x 900
ST03-3		2000 x 900



# DESKS



- DSK.01 - Rectangle
- DSK.02 - Triangle
- DSK.03 - Brick
- DSK.04 - Chain
- DSK.05 - Cube
- DSK.06 - Mix



# DESKS

DSK.01 - RECTANGLE



DSK.02 - TRIANGLE



DSK.03 - BRICK



DSK.04 - CHAIN



DSK.05 - CUBE

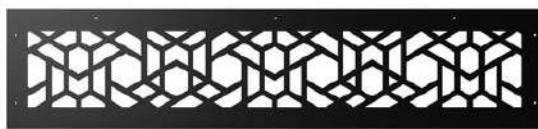

DSK06 - MIX



	D (mm)	W (mm)	H (mm)
DSK.01 - Rectangle	700	1600	760
DSK.02 - Triangle			
DSK.03 - Brick			
DSK.04 - Chain			
DSK.05 - Cube			
DSK06 - mix			

# ***COLLECTION ADDITION***



- AK.01
- AK.02



# COLLECTION ADDITION

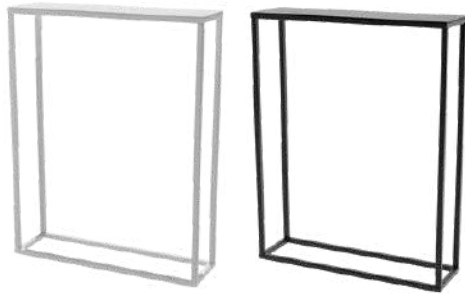

**AK.01-1 - METAL TOP**

	H (mm)	Top (mm)
AK.01-1	890	700 x 200

**AK.01-2 - WOOD TOP**

	H (mm)	Top (mm)
AK.01-2	890	700 x 200



# COLLECTION ADDITION

## AK.02 - METAL TOP



(A)

(B)

(C)

	SIZE (mm)
Stand (A)	300 x 300 x 1000
Stand (B)	250 x 250 x 800
Stand (C)	200 x 200 x 600

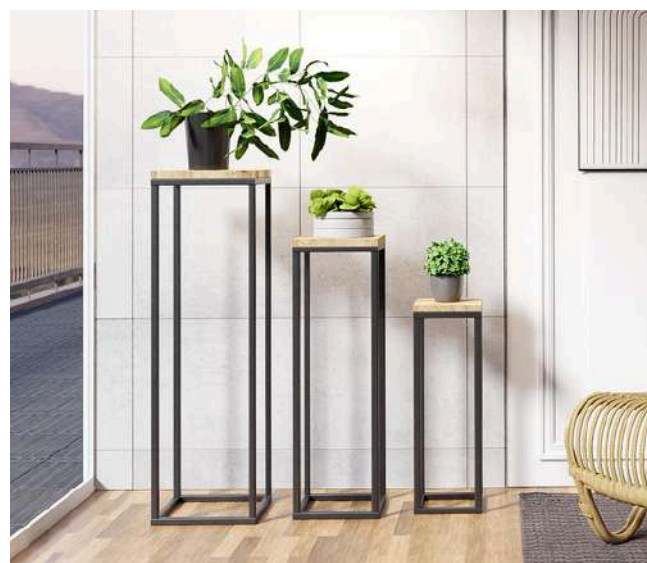



**ELEKTRON**  
FURNITURE